

# Adsorber VV-R series

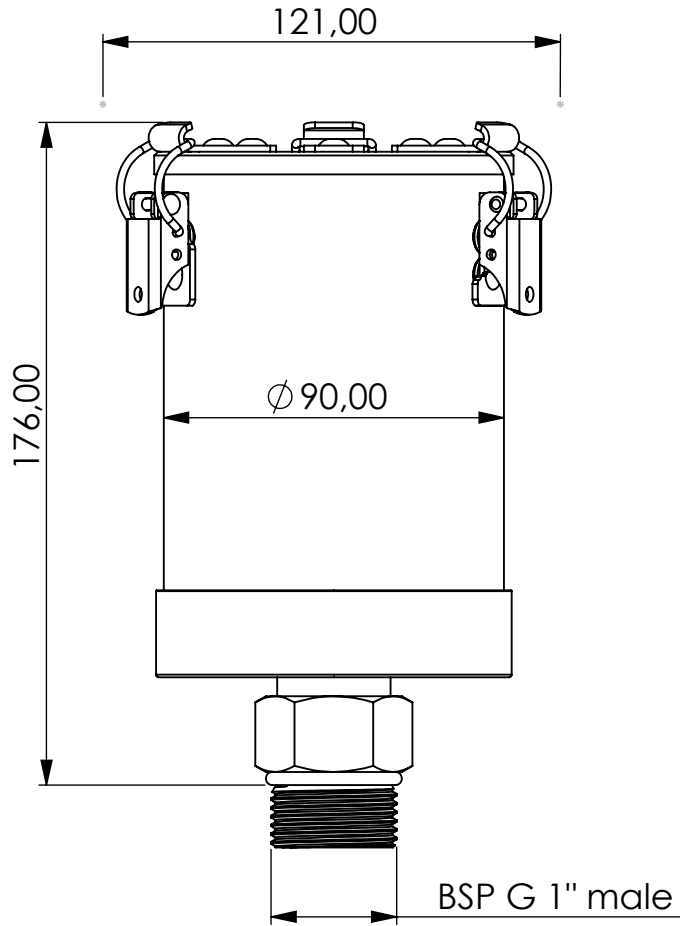

Product Code	<b>VV</b>	-	<b>R</b>	-	<b>2M</b>	-	<b>F</b>	-	<b>00</b>	-	<b>P3</b>	-	<b>SA</b>	-	<b>G1a</b>
	Adsorber type		Refillable cartridge		Size		FKM seals		No valves 0 IN 0 OUT		Paper filter 3 micron		Adsorbent Silica Gel Active carbon		Connection for System BSP G1" male

Housing materials:	PA6, PC, AL	
Silica Gel (kg):	0,3	Max. water adsorbtion (ml): 120
Total weight (kg):	0.92	

NAME:		
<b>Adsorber VV-R 2M G1"m</b>		
VV-R_2M_F_00_P3_SA_G1a		
Article no.:	Status freigabe	Format A4
<b>05.0020.56</b>	Maßstab	Blatt / von
	1:2	1 / 1

	Date	Name
rev.	01.04.2020	Daniel Zinic
 <b>GIEBEL Adsorber®</b> ...setting standards in aeration drying!		
GIEBEL FilTec GmbH <a href="http://www.giebel-adsorber.de">www.giebel-adsorber.de</a> <a href="mailto:info@giebel-adsorber.de">info@giebel-adsorber.de</a>		