

Ventilation System EBS

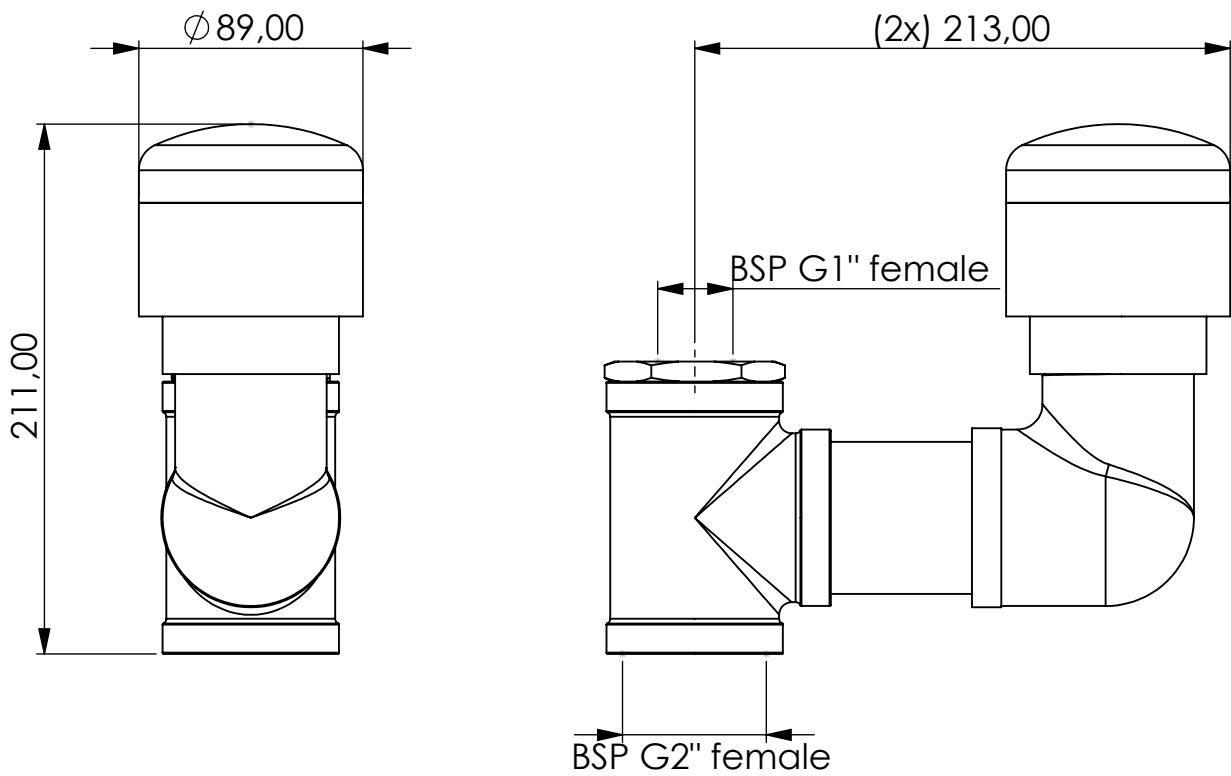
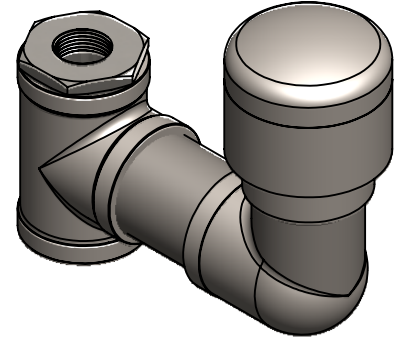

Product Code	EBS-ASM	-	SS	-	1	-	V0,008	-	G1f	-	G2f
	Ventilation System EBS Assembly		Material stainless steel 316L		1 Valve (out)		8mbar opening pressure		Connection for Adsorber BSP G1" female		Connection for System BSP G2" female

Total weight (kg): 2.932

NAME:

Ventilation System EBS
EBS-ASM_SS_1-V0,008_G1f_G2f

Article no.:
08.0000.43

Status approved

Format A4

Ratio 1:3

Sheet / of 1 / 1



GIEBEL Adsorber®
...setting standards in aeration drying!

GIEBEL FilTec GmbH
www.giebel-adsorber.de
info@giebel-adsorber.de